

# Xpole Industrial Feeder and Branch Circuit Breaker



Xpole Industrial, the logical continuation of the development of installation products for industrial applications. From protective switches to modular installation devices to surge protection, everything matches, and the complete range combines all the benefits.



## Xpole Industrial Product Information

Feeder and Branch Circuit Breaker  
FAZ-NA  
FAZ-RT (Ring Tonque Connection)

**MOELLER** 

An Eaton Brand

# Optimum and Efficient Protection for Every Application



**10 kA** | UL 489, C22.2 No.5

**15 kA** | IEC 60947-2

When it comes to protection and switching, industries in many countries rely on Moeller products.

Optimum product quality, tested reliability and safety stand for best protection of personnel, installations and plant. Approvals in many countries confirm Moeller builds its products to comply with the latest national and international Regulations.

## Powerful offering for machine and system builders

The Xpole Industrial FAZ-NA, FAZ-RT is available with C and D characteristic in accordance with UL 489, CSA C22.2 No.5; UL 1077, CSA C22.2 No.235 and IEC 60947-2

## Typical Applications

### Feeder and Branch Circuit Protection

- Convenience receptacle circuits (internal/external)
- Motors (internal/external)
- Load circuits leaving the equipment (external)
- HACR Equipment (Heating, Air Conditioning, Refrigeration) (internal/external)

### Supplementary Protection FAZ, FAZ-NA and FAZ-RT

- Additional protection for: sensitive equipment, electronic components (e.g. computers)
- Motor control circuits without transformers

## Features

- Current limiting
- SWD (switching duty) – suitable for switching fluorescent lighting loads ( $I_n \leq 20$  A)
- Fulfill UL 489, CSA C22.2 No. 5 and also IEC 60947-2 Standard
- For use in application for which UL 1077 or CSA C22.2 No.235 are also allowed
- Shunt trip release and auxiliary switch for subsequent mounting
- Separate Version for Ring Tonque Connection (Type FAZ-....-RT), terminal screws can be removed (on both sides)
- Module width of only 17,7 mm (per pole)
- Contact Position Indicator (red/green)
- Easy installation on DIN rail
- Possibility for sealing the toggle in on- or off-position



Captive screws cannot be lost

FAZ-NA



FAZ-RT



FAZ-RT



# FAZ complies with the latest national and international Standards

## Standards – Feeder and Branch Circuit Protection

- **UL 489**

Standard for molded case circuit breakers (MCCB) for feeder and branch circuit protection.

Products meet the requirements of the National Electrical Code (NEC).



- **CSA C22.2 No.5**

Standard for molded case circuit breakers (MCCB) for feeder and branch circuit protection (corresponds closely to UL 489 Standard).

Products meet the requirements of the Canadian Electrical Code (CEC)



## Standards – Supplementary Protection

- **UL 1077**

Standard for molded case circuit breakers (MCCB) for supplementary protection of sensitive electronic equipment or equipment that requires unique or specific overcurrent protection.

Products meet the requirements of the National Electrical Code (NEC).



- **CSA C22.2 No.235**

Equivalent to the UL 1077 Standard.

Products meet the requirements of the Canadian Electrical Code (CEC).



# Device Printing on front and side

**Type Designation:** FAZ-C20/1-NA

**Min. distance between front plate and device shoulder:** min. 0.25 in / 6 mm

**According to Standard IEC/EN:** EN/IEC 60947-2

**Rated Voltage IEC/EN:** 240/415V~ 50/60Hz

**Rated Breaking Capacity IEC/EN:** Icu=15kA Ics=7,5kA

**Reference Calibration Temperature:** Ret. 30°C Cat. A

**Rated Impulse Withstand Voltage:** Uimp = 4kV

**Utilisation Category:** DVE

**German Approval Mark:** UL LISTED E235139

**Suitable for 60/75°C wire:** 60/75°C

**Length of uninsulated conductor:** 12 mm / 0.5 in

**Rated Voltage UL/CSA:** 277V~ 480V=

**Heating, Air Conditioning, Refrigeration:** HACR

**Issue No.:** AB-5430

**1 POLE UNIT**

**DISJ.**

**CIRCUIT BREAKER**

**INT. RATING 10kA**

**CURRENT LIMITING**  
58 kA²s, 6.2 kA peak

**AWG TORQUE**

18-12	21 lb-in	1 WIRE	AWG 18-6
10-8	25 lb-in	2 WIRES	AWG 18-10
6	36 lb-in		

**EAN-Code:** 23456X

**Rated Breaking Capacity UL/CSA:** XXXXX1

**Current Limiting:** XXXXX1

**Switching Duty:** XXXXX1

**Terminal Capacity:** XXXXX1

Cu-conductors only

Calibration Temperature acc. UL/CSA

Rated Voltage UL/CSA

Suitable for Insolation

Rated Current

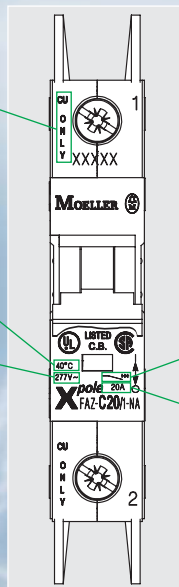



## Miniature Circuit Breakers FAZ-NA

15 kA IEC; 10 kA UL/CSA, Characteristic C

SG11805



Rated current $I_n$ (A)	Type Designation	Article No.	Units per package
-------------------------	------------------	-------------	-------------------

### 1-pole

0.5	FAZ-C0,5/1-NA	102077	2 / 80
1	FAZ-C1/1-NA	102078	2 / 80
1.5	FAZ-C1,5/1-NA	102079	2 / 80
2	FAZ-C2/1-NA	102080	2 / 80
3	FAZ-C3/1-NA	102081	2 / 80
4	FAZ-C4/1-NA	102082	2 / 80
5	FAZ-C5/1-NA	102083	2 / 80
6	FAZ-C6/1-NA	102084	2 / 80
7	FAZ-C7/1-NA	102085	2 / 80
8	FAZ-C8/1-NA	102086	2 / 80
10	FAZ-C10/1-NA	102087	2 / 80
13	FAZ-C13/1-NA	102088	2 / 80
15	FAZ-C15/1-NA	102089	2 / 80
16	FAZ-C16/1-NA	102090	2 / 80
20	FAZ-C20/1-NA	102091	2 / 80
25	FAZ-C25/1-NA	102092	2 / 80
30	FAZ-C30/1-NA	102093	2 / 80
32	FAZ-C32/1-NA	102094	2 / 80
35	FAZ-C35/1-NA	102095	2 / 80
40	FAZ-C40/1-NA	102096	2 / 80

SG12105



### 2-pole

0.5	FAZ-C0,5/2-NA	102157	1 / 40
1	FAZ-C1/2-NA	102158	1 / 40
1.5	FAZ-C1,5/2-NA	102159	1 / 40
2	FAZ-C2/2-NA	102160	1 / 40
3	FAZ-C3/2-NA	102161	1 / 40
4	FAZ-C4/2-NA	102162	1 / 40
5	FAZ-C5/2-NA	102163	1 / 40
6	FAZ-C6/2-NA	102164	1 / 40
7	FAZ-C7/2-NA	102165	1 / 40
8	FAZ-C8/2-NA	102166	1 / 40
10	FAZ-C10/2-NA	102167	1 / 40
13	FAZ-C13/2-NA	102168	1 / 40
15	FAZ-C15/2-NA	102169	1 / 40
16	FAZ-C16/2-NA	102170	1 / 40
20	FAZ-C20/2-NA	102171	1 / 40
25	FAZ-C25/2-NA	102172	1 / 40
30	FAZ-C30/2-NA	102173	1 / 40
32	FAZ-C32/2-NA	102174	1 / 40
35	FAZ-C35/2-NA	102175	1 / 40
40	FAZ-C40/2-NA	102176	1 / 40

SG12205



### 3-pole

0.5	FAZ-C0,5/3-NA	102237	1 / 28
1	FAZ-C1/3-NA	102238	1 / 28
1.5	FAZ-C1,5/3-NA	102239	1 / 28
2	FAZ-C2/3-NA	102240	1 / 28
3	FAZ-C3/3-NA	102241	1 / 28
4	FAZ-C4/3-NA	102242	1 / 28
5	FAZ-C5/3-NA	102243	1 / 28
6	FAZ-C6/3-NA	102244	1 / 28
7	FAZ-C7/3-NA	102245	1 / 28
8	FAZ-C8/3-NA	102246	1 / 28
10	FAZ-C10/3-NA	102247	1 / 28
13	FAZ-C13/3-NA	102248	1 / 28
15	FAZ-C15/3-NA	102249	1 / 28
16	FAZ-C16/3-NA	102250	1 / 28
20	FAZ-C20/3-NA	102251	1 / 28
25	FAZ-C25/3-NA	102252	1 / 28
30	FAZ-C30/3-NA	102253	1 / 28
32	FAZ-C32/3-NA	102254	1 / 28
35	FAZ-C35/3-NA	102255	1 / 28
40	FAZ-C40/3-NA	102256	1 / 28

## Miniature Circuit Breakers FAZ-NA

15 kA IEC; 10 kA UL/CSA, Characteristic D

SG11805



Rated current $I_n$ (A)	Type Designation	Article No.	Units per package
-------------------------	------------------	-------------	-------------------

### 1-pole

0.5	FAZ-D0,5/1-NA	102097	2 / 80
1	FAZ-D1/1-NA	102098	2 / 80
1.5	FAZ-D1,5/1-NA	102099	2 / 80
2	FAZ-D2/1-NA	102100	2 / 80
3	FAZ-D3/1-NA	102101	2 / 80
4	FAZ-D4/1-NA	102102	2 / 80
5	FAZ-D5/1-NA	102103	2 / 80
6	FAZ-D6/1-NA	102104	2 / 80
7	FAZ-D7/1-NA	102105	2 / 80
8	FAZ-D8/1-NA	102106	2 / 80
10	FAZ-D10/1-NA	102107	2 / 80
13	FAZ-D13/1-NA	102108	2 / 80
15	FAZ-D15/1-NA	102109	2 / 80
16	FAZ-D16/1-NA	102110	2 / 80
20	FAZ-D20/1-NA	102111	2 / 80
25	FAZ-D25/1-NA	102112	2 / 80
30	FAZ-D30/1-NA	102113	2 / 80
32	FAZ-D32/1-NA	102114	2 / 80
35	FAZ-D35/1-NA	102115	2 / 80
40	FAZ-D40/1-NA	102116	2 / 80

SG12105



### 2-pole

0.5	FAZ-D0,5/2-NA	102177	1 / 40
1	FAZ-D1/2-NA	102178	1 / 40
1.5	FAZ-D1,5/2-NA	102179	1 / 40
2	FAZ-D2/2-NA	102180	1 / 40
3	FAZ-D3/2-NA	102181	1 / 40
4	FAZ-D4/2-NA	102182	1 / 40
5	FAZ-D5/2-NA	102183	1 / 40
6	FAZ-D6/2-NA	102184	1 / 40
7	FAZ-D7/2-NA	102185	1 / 40
8	FAZ-D8/2-NA	102186	1 / 40
10	FAZ-D10/2-NA	102187	1 / 40
13	FAZ-D13/2-NA	102188	1 / 40
15	FAZ-D15/2-NA	102189	1 / 40
16	FAZ-D16/2-NA	102190	1 / 40
20	FAZ-D20/2-NA	102191	1 / 40
25	FAZ-D25/2-NA	102192	1 / 40
30	FAZ-D30/2-NA	102193	1 / 40
32	FAZ-D32/2-NA	102194	1 / 40
35	FAZ-D35/2-NA	102195	1 / 40
40	FAZ-D40/2-NA	102196	1 / 40

SG12205



### 3-pole

0.5	FAZ-D0,5/3-NA	102257	1 / 28
1	FAZ-D1/3-NA	102258	1 / 28
1.5	FAZ-D1,5/3-NA	102259	1 / 28
2	FAZ-D2/3-NA	102260	1 / 28
3	FAZ-D3/3-NA	102261	1 / 28
4	FAZ-D4/3-NA	102262	1 / 28
5	FAZ-D5/3-NA	102263	1 / 28
6	FAZ-D6/3-NA	102264	1 / 28
7	FAZ-D7/3-NA	102265	1 / 28
8	FAZ-D8/3-NA	102266	1 / 28
10	FAZ-D10/3-NA	102267	1 / 28
13	FAZ-D13/3-NA	102268	1 / 28
15	FAZ-D15/3-NA	102269	1 / 28
16	FAZ-D16/3-NA	102270	1 / 28
20	FAZ-D20/3-NA	102271	1 / 28
25	FAZ-D25/3-NA	102272	1 / 28
30	FAZ-D30/3-NA	102273	1 / 28
32	FAZ-D32/3-NA	102274	1 / 28
35	FAZ-D35/3-NA	102275	1 / 28
40	FAZ-D40/3-NA	102276	1 / 28

SG11905



## Miniature Circuit Breakers FAZ-NA-DC 125 V DC; 10 kA UL489A, Characteristic C

Rated current $I_n$ (A)	Type Designation	Article No.	Units per package
<b>1-pole</b>			
2	FAZ-C2/1-NA-DC	113752	2 / 80
3	FAZ-C3/1-NA-DC	113753	2 / 80
4	FAZ-C4/1-NA-DC	113754	2 / 80
5	FAZ-C5/1-NA-DC	113755	2 / 80
6	FAZ-C6/1-NA-DC	113756	2 / 80
7	FAZ-C7/1-NA-DC	113757	2 / 80
8	FAZ-C8/1-NA-DC	113758	2 / 80
10	FAZ-C10/1-NA-DC	113759	2 / 80
13	FAZ-C13/1-NA-DC	113760	2 / 80
15	FAZ-C15/1-NA-DC	113761	2 / 80
16	FAZ-C16/1-NA-DC	113762	2 / 80
20	FAZ-C20/1-NA-DC	113763	2 / 80
25	FAZ-C25/1-NA-DC	113764	2 / 80
30	FAZ-C30/1-NA-DC	113765	2 / 80
32	FAZ-C32/1-NA-DC	113766	2 / 80
35	FAZ-C35/1-NA-DC	113767	2 / 80
40	FAZ-C40/1-NA-DC	113768	2 / 80



# FAZ-RT (with Ring Tongue Connection)

SG11905



SG12005



SG12305



## Miniature Circuit Breakers FAZ-RT 15 kA IEC; 10 kA UL/CSA, Characteristic C

Rated current $I_n$ (A)	Type Designation	Article No.	Units per package
<b>1-pole</b>			
0.5	FAZ-C0,5/1-RT	102117	2 / 80
1	FAZ-C1/1-RT	102118	2 / 80
1.5	FAZ-C1,5/1-RT	102119	2 / 80
2	FAZ-C2/1-RT	102120	2 / 80
3	FAZ-C3/1-RT	102121	2 / 80
4	FAZ-C4/1-RT	102122	2 / 80
5	FAZ-C5/1-RT	102123	2 / 80
6	FAZ-C6/1-RT	102124	2 / 80
7	FAZ-C7/1-RT	102125	2 / 80
8	FAZ-C8/1-RT	102126	2 / 80
10	FAZ-C10/1-RT	102127	2 / 80
13	FAZ-C13/1-RT	102128	2 / 80
15	FAZ-C15/1-RT	102129	2 / 80
16	FAZ-C16/1-RT	102130	2 / 80
20	FAZ-C20/1-RT	102131	2 / 80
25	FAZ-C25/1-RT	102132	2 / 80
30	FAZ-C30/1-RT	102133	2 / 80
32	FAZ-C32/1-RT	102134	2 / 80
35	FAZ-C35/1-RT	102135	2 / 80
40	FAZ-C40/1-RT	102136	2 / 80

<b>2-pole</b>			
0.5	FAZ-C0,5/2-RT	102197	1 / 40
1	FAZ-C1/2-RT	102198	1 / 40
1.5	FAZ-C1,5/2-RT	102199	1 / 40
2	FAZ-C2/2-RT	102200	1 / 40
3	FAZ-C3/2-RT	102201	1 / 40
4	FAZ-C4/2-RT	102202	1 / 40
5	FAZ-C5/2-RT	102203	1 / 40
6	FAZ-C6/2-RT	102204	1 / 40
7	FAZ-C7/2-RT	102205	1 / 40
8	FAZ-C8/2-RT	102206	1 / 40
10	FAZ-C10/2-RT	102207	1 / 40
13	FAZ-C13/2-RT	102208	1 / 40
15	FAZ-C15/2-RT	102209	1 / 40
16	FAZ-C16/2-RT	102210	1 / 40
20	FAZ-C20/2-RT	102211	1 / 40
25	FAZ-C25/2-RT	102212	1 / 40
30	FAZ-C30/2-RT	102213	1 / 40
32	FAZ-C32/2-RT	102214	1 / 40
35	FAZ-C35/2-RT	102215	1 / 40
40	FAZ-C40/2-RT	102216	1 / 40

<b>3-pole</b>			
0.5	FAZ-C0,5/3-RT	102277	1 / 28
1	FAZ-C1/3-RT	102278	1 / 28
1.5	FAZ-C1,5/3-RT	102279	1 / 28
2	FAZ-C2/3-RT	102280	1 / 28
3	FAZ-C3/3-RT	102281	1 / 28
4	FAZ-C4/3-RT	102282	1 / 28
5	FAZ-C5/3-RT	102283	1 / 28
6	FAZ-C6/3-RT	102284	1 / 28
7	FAZ-C7/3-RT	102285	1 / 28
8	FAZ-C8/3-RT	102286	1 / 28
10	FAZ-C10/3-RT	102287	1 / 28
13	FAZ-C13/3-RT	102288	1 / 28
15	FAZ-C15/3-RT	102289	1 / 28
16	FAZ-C16/3-RT	102290	1 / 28
20	FAZ-C20/3-RT	102291	1 / 28
25	FAZ-C25/3-RT	102292	1 / 28
30	FAZ-C30/3-RT	102293	1 / 28
32	FAZ-C32/3-RT	102294	1 / 28
35	FAZ-C35/3-RT	102295	1 / 28
40	FAZ-C40/3-RT	102296	1 / 28

# FAZ-RT (with Ring Tongue Connection)

SG11905



SG12005



SG12305



## Miniature Circuit Breakers FAZ-RT 15 kA IEC; 10 kA UL/CSA, Characteristic D

Rated current $I_n$ (A)	Type Designation	Article No.	Units per package
<b>1-pole</b>			
0.5	FAZ-D0,5/1-RT	102137	2 / 80
1	FAZ-D1/1-RT	102138	2 / 80
1.5	FAZ-D1,5/1-RT	102139	2 / 80
2	FAZ-D2/1-RT	102140	2 / 80
3	FAZ-D3/1-RT	102141	2 / 80
4	FAZ-D4/1-RT	102142	2 / 80
5	FAZ-D5/1-RT	102143	2 / 80
6	FAZ-D6/1-RT	102144	2 / 80
7	FAZ-D7/1-RT	102145	2 / 80
8	FAZ-D8/1-RT	102146	2 / 80
10	FAZ-D10/1-RT	102147	2 / 80
13	FAZ-D13/1-RT	102148	2 / 80
15	FAZ-D15/1-RT	102149	2 / 80
16	FAZ-D16/1-RT	102150	2 / 80
20	FAZ-D20/1-RT	102151	2 / 80
25	FAZ-D25/1-RT	102152	2 / 80
30	FAZ-D30/1-RT	102153	2 / 80
32	FAZ-D32/1-RT	102154	2 / 80
35	FAZ-D35/1-RT	102155	2 / 80
40	FAZ-D40/1-RT	102156	2 / 80
<b>2-pole</b>			
0.5	FAZ-D0,5/2-RT	102217	1 / 40
1	FAZ-D1/2-RT	102218	1 / 40
1.5	FAZ-D1,5/2-RT	102219	1 / 40
2	FAZ-D2/2-RT	102220	1 / 40
3	FAZ-D3/2-RT	102221	1 / 40
4	FAZ-D4/2-RT	102222	1 / 40
5	FAZ-D5/2-RT	102223	1 / 40
6	FAZ-D6/2-RT	102224	1 / 40
7	FAZ-D7/2-RT	102225	1 / 40
8	FAZ-D8/2-RT	102226	1 / 40
10	FAZ-D10/2-RT	102227	1 / 40
13	FAZ-D13/2-RT	102228	1 / 40
15	FAZ-D15/2-RT	102229	1 / 40
16	FAZ-D16/2-RT	102230	1 / 40
20	FAZ-D20/2-RT	102231	1 / 40
25	FAZ-D25/2-RT	102232	1 / 40
30	FAZ-D30/2-RT	102233	1 / 40
32	FAZ-D32/2-RT	102234	1 / 40
35	FAZ-D35/2-RT	102235	1 / 40
40	FAZ-D40/2-RT	102236	1 / 40
<b>3-pole</b>			
0.5	FAZ-D0,5/3-RT	102297	1 / 28
1	FAZ-D1/3-RT	102298	1 / 28
1.5	FAZ-D1,5/3-RT	102299	1 / 28
2	FAZ-D2/3-RT	102300	1 / 28
3	FAZ-D3/3-RT	102301	1 / 28
4	FAZ-D4/3-RT	102302	1 / 28
5	FAZ-D5/3-RT	102303	1 / 28
6	FAZ-D6/3-RT	102304	1 / 28
7	FAZ-D7/3-RT	102305	1 / 28
8	FAZ-D8/3-RT	102306	1 / 28
10	FAZ-D10/3-RT	102307	1 / 28
13	FAZ-D13/3-RT	102308	1 / 28
15	FAZ-D15/3-RT	102309	1 / 28
16	FAZ-D16/3-RT	102310	1 / 28
20	FAZ-D20/3-RT	102311	1 / 28
25	FAZ-D25/3-RT	102312	1 / 28
30	FAZ-D30/3-RT	102313	1 / 28
32	FAZ-D32/3-RT	102314	1 / 28
35	FAZ-D35/3-RT	102315	1 / 28
40	FAZ-D40/3-RT	102316	1 / 28

## Miniature Circuit Breakers FAZ-NA, FAZ-RT

### Accessories:

Tripping signal switch for subsequent installation	Z-NHK
Shunt trip release	FAZ-XAA-NA
Busbar-System	Z-SV/UL-16/

### Connection diagrams

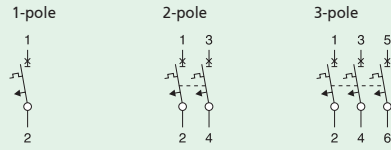

### Technical Data

#### Electrical

Design according to	UL 489, CSA C22.2 No.5, IEC 60947-2
Rated voltage	UL/CSA 0.5 - 25 A 277/480Y VAC
	UL/CSA 32 - 40 A 240 VAC
UL/CSA (per pole)	48 VDC
IEC	240/415 VAC
Rated frequency	50/60 Hz
Rated breaking capacity	UL/CSA 10 kA
	IEC 15 kA
Characteristic	C, D
Endurance	≥ 20,000 operations
Line voltage connection	optional suitable for reverse feed

#### Mechanical

Frame size	45 mm
Device height	105 mm
Device width	17.7 mm per pole
Mounting	quick fastening with 2 lock-in positions on IEC/EN 60715
Upper and lower terminals	open mouth/lift terminals
Terminal capacity	1 Wire AWG 18-6
	2 Wires AWG 18-10
Terminal fastening torque	AWG 18-21: 21 lb-in
	AWG 10-8: 25 lb-in
	AWG 6: 36 lb-in
Mounting	independent of position
Calibration temperature	UL 489, CSA C22.2 No.5 40°C
	IEC 60947-2 30°C

### Dimensions (mm)

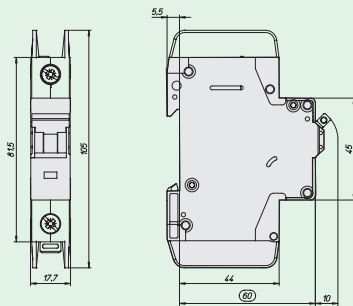

### Power loss at $I_n$

#### Characteristic C

	1p	2p	3p
$I_n$ [A]	P [W]	P [W]	P [W]
0.5	1.6	3.2	4.7
1	1.1	2.2	3.4
1.5	1.3	2.6	3.9
2	1.4	2.8	4.3
3	1.2	2.4	3.6
4	1.4	2.9	4.3
5	1.9	3.7	5.6
6	1.2	2.3	3.5
7	1.4	2.8	4.3
8	1.4	2.8	4.2
10	1.8	3.6	5.3
13	2.4	4.7	7.1
15	1.9	3.8	5.6
16	2.1	4.3	6.4
20	2.9	5.8	8.7
25	3.1	6.2	9.3
30	3.0	6.0	9.0
32	3.4	6.8	10.2
35	3.7	7.4	11.0
40	4.0	8.1	12.1

#### Characteristic D

	1p	2p	3p
$I_n$ [A]	P [W]	P [W]	P [W]
0.5	1.6	3.2	4.8
1	0.8	1.5	2.3
1.5	1.0	2.1	3.1
2	1.0	2.1	3.1
3	1.2	2.4	3.6
4	1.4	2.9	4.3
5	1.5	2.9	4.4
6	1.2	2.3	3.5
7	1.4	2.8	4.3
8	1.2	2.4	3.7
10	1.5	3.0	4.5
13	2.0	4.1	6.1
15	1.5	3.1	4.6
16	1.7	3.5	5.2
20	1.8	3.7	5.5
25	2.6	5.1	7.7
30	2.7	5.4	8.1
32	3.1	6.2	9.3
35	3.8	7.6	11.3
40	3.9	7.8	11.6

### Tripping Characteristics

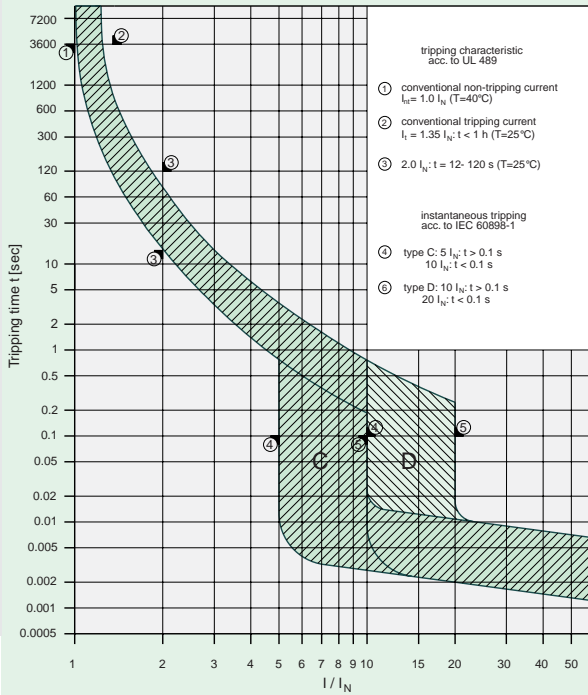

### Influence of ambient temperature T on load carrying capacity

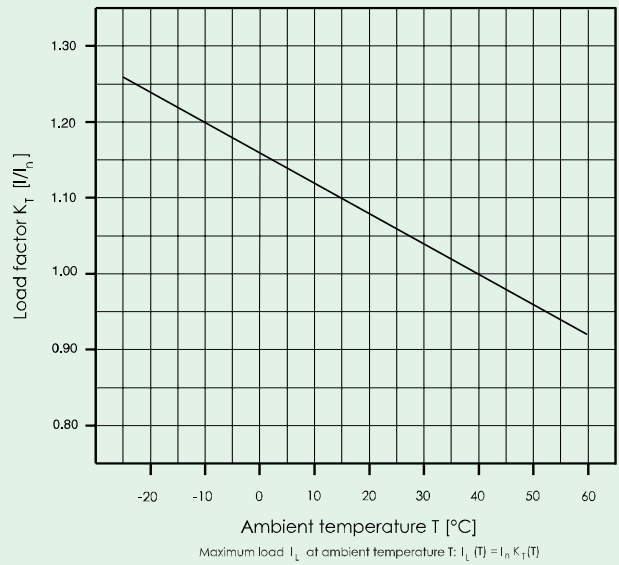

### Let-through Energy

Characteristic C (0.5-20A), 277V

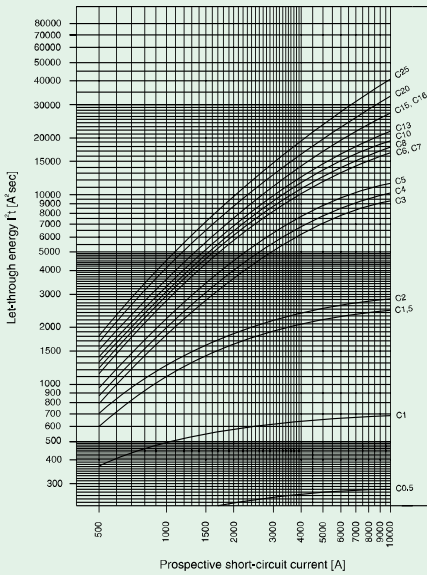

Characteristic C (25-40A), 240V

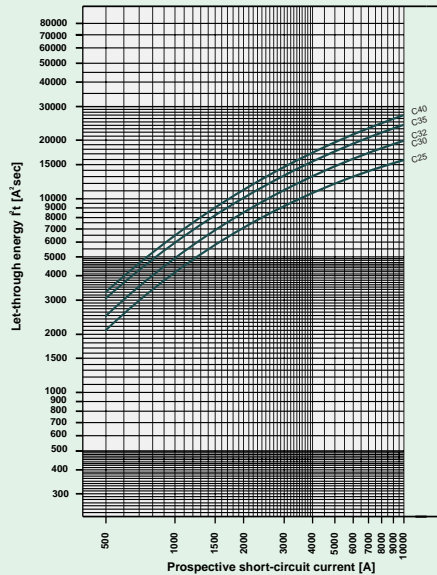

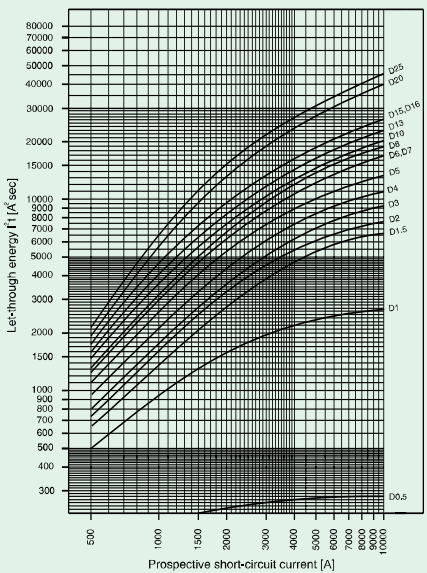

Characteristic D (0.5-20A), 277V



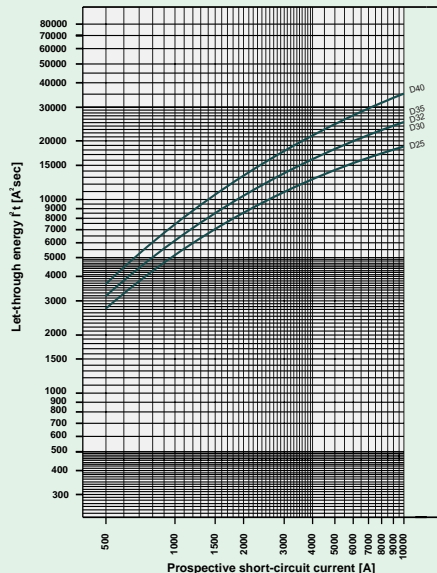









Characteristic D (25-40A), 240V





		Accessories			
		Type Designation	Article No.	Units per package	
	SG12002	Tripping signal switch	Z-NHK	248434	4 / 120
	SG02008	Auxiliary Switch	Z-IHK-NA	113895	2 / 240

	sg02208	Shunt trip release 110-415VAC	FAZ-XAA-NA110-415VAC	102036	1
		Shunt trip release 12-110VAC	FAZ-XAA-NA12-110VAC	102037	1

Description	Type Designation	Article No.	Units per package
<b>Busbar block UL489 (Pin), Z-SV/UL-16/</b>			
for FAZ-NA, FAZ-RT			
<ul style="list-style-type: none"> <li>Do not cut!  <b>16 mm<sup>2</sup></b> <ul style="list-style-type: none"> <li>Rated current 80 A</li> </ul> </li> </ul>			
1-phase, 6MU	Z-SV/UL-16/1P-1TE/6	104892	10 / 200
1-phase, 12MU	Z-SV/UL-16/1P-1TE/12	104893	10 / 200
1-phase, 18MU	Z-SV/UL-16/1P-1TE/18	104894	10 / 40
2-phases, 6MU	Z-SV/UL-16/2P-2TE/6	104895	10 / 200
2-phases, 12MU	Z-SV/UL-16/2P-2TE/12	104896	10 / 200
2-phases, 18MU	Z-SV/UL-16/2P-2TE/18	104897	10 / 40
3-phases, 6MU	Z-SV/UL-16/3P-3TE/6	104898	10 / 200
3-phases, 12MU	Z-SV/UL-16/3P-3TE/12	104899	10 / 200
3-phases, 18MU	Z-SV/UL-16/3P-3TE/18	104900	10 / 40

Devices to busbar	Pcs. of the devices	Type
<b>1-phase</b>		
	x6	Z-SV/UL-16/1P-1TE/6
	x12	Z-SV/UL-16/1P-1TE/12
	x18	Z-SV/UL-16/1P-1TE/18
<b>2-phases</b>		
	x3	Z-SV/UL-16/2P-2TE/6
	x6	Z-SV/UL-16/2P-2TE/12
	x9	Z-SV/UL-16/2P-2TE/18
<b>3-phases</b>		
	x2	Z-SV/UL-16/3P-3TE/6
	x4	Z-SV/UL-16/3P-3TE/12
	x6	Z-SV/UL-16/3P-3TE/18

		Accessories			
		Description	Type Designation	Article No.	Units per package
	SG07506	<b>Extension Terminal 35 mm<sup>2</sup> UL489, Z-EK/35/UL</b>			
		2.5-35mm <sup>2</sup> , AWG 14-2	Z-EK/35/UL	104901	3 / 180
	SG07706	<b>Busbar Tag Shrouds UL489, ZV-BS-UL</b>			
		for 3 pins	ZV-BS-UL	104904	10 / 600

## Tripping Signal Switch Z-NHK, Z-IHK-NA

- Design according to IEC/EN 60947-5-1, IEC/EN 62019
- Can be mounted subsequently (screws)
- The specified minimum voltages are per contact  
Take into account particularly in case of series connection!
- Contact function with relative movement (self-cleaning contacts)
- Contact material and design particularly suitable for extra low voltage
- **Z-NHK:** The function of one of the two change-over contacts can be switched from "auxiliary switch" to "tripping signal switch"
- **Z-IHK-NA:** will allow for FAZ-NA > 480Y/277 VAC rating
- Tripping signal contact transmits message of electric tripping, not mechanical switch-off
- Test key for contact function "electrical tripping"

### Connection diagram

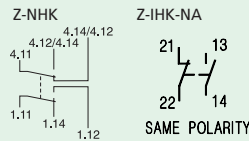

## Technical Data

	Z-NHK	Z-IHK-NA
<b>Electrical</b>		
Can be mounted from the left onto	FAZ-NA, FAZ-RT, FAZ-XAA-NA	
Contact function	2CO	1NO + 1NC
Rated voltage	230 V	250 V
Frequency	50/60 Hz	50/60 Hz
Rated current	2 A	6 A
Rated thermal current $I_{th}$	2 A	6 A
Utilisation category AC13		
Rated operational current $I_e$	3A/250V AC	3A/250V AC
Utilisation category AC15		
Rated operational current $I_e$	2A/250V AC	2A/250V AC
Utilisation category DC12		
Rated operational current $I_e$	0.5A/110V DC	0.5A/110V DC 0.25A/220V DC
Rated insulation voltage $U_i$	250 V AC	250 V AC
Minimum operational voltage per contact $U_{min}$	5 V DC	5 V DC
Minimum operational current $I_{min}$	10 mA DC	10 mA AC/DC
Rated peak withstand voltage $U_{imp}$ (1.2/50 $\mu$ )	2.5 kV	4 kV
Conditional short circuit current $I_k$ with back-up fuse 6A	1 kA	1 kA
Max. back-up fuse, overload and short circuit	6 A gL	
<b>Mechanical</b>		
Tripping indicator "electrical tripping"	blue/white	-
Frame size	45 mm	45 mm
Device height	80 mm	80 mm
Device width	8.8 mm (0.5MU)	8.8 mm (0.5MU)
Mounting	onto switching dev.	
Degree of protection, built-in	IP40	IP40
Terminal protection	finger and hand touch safe according to BGV A3, ÖVE-EN 6	finger and hand touch safe according to BGV A3, ÖVE-EN 6
Terminals	lift terminals	lift terminals
Terminal capacity	20-14 AWG	0.5-2.5 mm <sup>2</sup>
Terminal screws	M3 (Pozidrive Z0)	M3 (Pozidrive Z0)
Fastening torque of terminal screws	7 lb-in	max. 1.2 Nm

The voltage of the FAZ-... Circuit Breaker is limited to 300 V with this Auxiliary Switch installed.

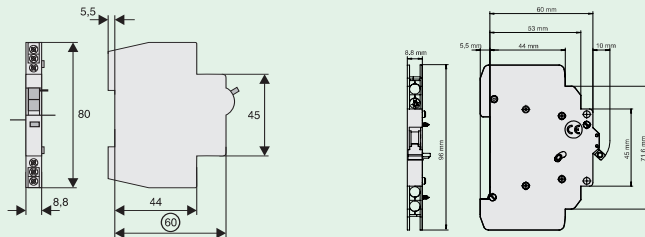



## Shunt Trip Release FAZ-XAA-NA

- Remote release for subsequent mounting onto FAZ-NA and FAZ-RT
- Module width 1MU
- Additional installation of standard auxiliary switch is possible
- Position indicator red - green

### Connection diagram

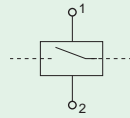

### Technical Data

	FAZ-XAA-NA12-110VAC	FAZ-XAA-NA110-415VAC
<b>Electrical</b>		
Can be mounted onto	FAZ-NA, FAZ-RT	FAZ-NA, FAZ-RT
Operational voltage range	12-110V AC 12-60V DC	110-415V AC 110-230V DC
Frequency	50/60 Hz	50/60 Hz
Possible standard auxiliary switch	Z-NHK	Z-NHK
<b>Mechanical</b>		
Frame size	45 mm	45 mm
Device height	105 mm	105 mm
Device width	17.5 mm (1MU)	17.5 mm (1MU)
Mounting	quick fastening with 2 lock-in positions on DIN rail EN 50022	
Degree of protection, built-in	IP40	IP40
Terminal protection	finger and hand touch safe according to BGV A3, ÖVE-EN 6	
Terminals	open mouthed/lift	open mouthed/lift
Terminal capacity 1 and 2 Wires	AWG 18-10	AWG 18-10

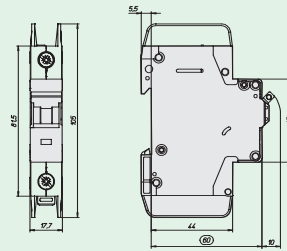

## Busbar Block UL489 (Pin), Z-SV/UL-16/

for FAZ-NA, FAZ-RT

- Tested according to UL489
- Do not cut
- Extension terminal 35 mm<sup>2</sup> Z-EK/35/UL for copper conductors
- For covering of not used pins use busbar tag shrouds ZV-BS-UL

### Connection diagram

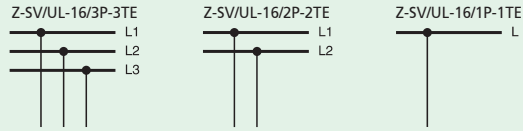

### Technical Data

UL489

IEC/EN60947-2

### Electrical

Rated operational voltage	480/277 VAC
	96 VDC
Rated frequency	50/60 Hz
Rated voltage	–
Overvoltage category	–
Rated impulse withstand voltage $U_{imp}$	–
Rated current	80 A
Rated conditional short-circuit current AC with 350 A gG	–
Short-circuit current	10 kA

690 VAC

III

9.5 kV

80 A

15 kA

–

### Mechanical

Busbar cross section	–	16 mm <sup>2</sup> Cu
Flame class acc. to UL94	V0	
Pollution degree	–	2
Comparative tracking index	–	CTI 600
Minimum clearance (intern/extern)	–	> 9.5 / 25.4 mm
Minimum creepage distance (intern/extern)	–	> 12.7 / 50.8 mm
Resistance to climatic conditions	–	acc. to DIN/EN60068

### Dimensions (mm)

Z-SV/UL-16/TE/6

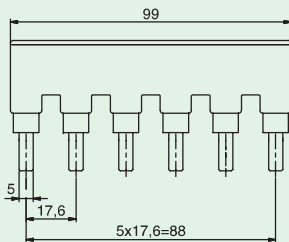

Z-SV/UL-16/TE/12

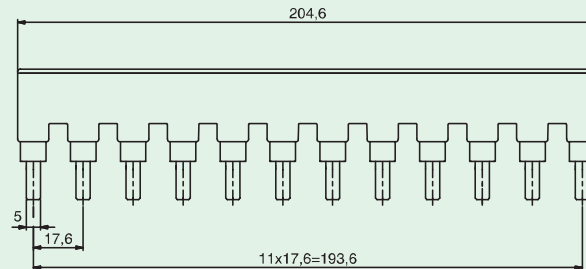

ZV-BS-UL

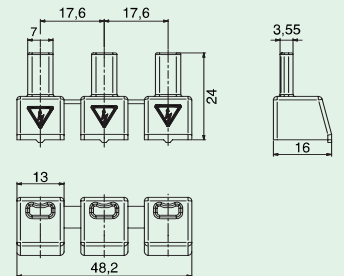

Z-SV/UL-16/TE/18

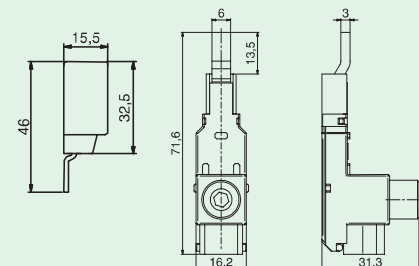
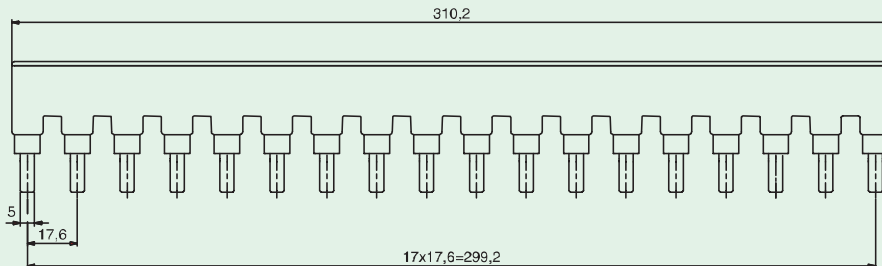

### Busbar Connection Example

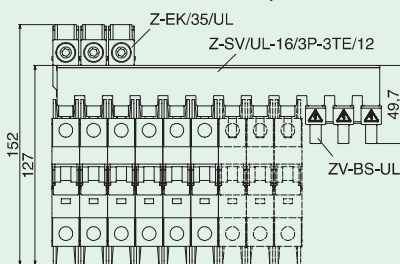

Z-EK/35/UL

	UL489	IEC/EN60947-2
	# 2-14 AWG 60/75°C Cu	2.5-35 mm <sup>2</sup> Cu
	0.56 in	14 mm

tested acc. to

		Tightening torque of terminal screws
UL486A	# 14 AWG	≥ 2.3 Nm
UL486B	# 8-12 AWG	≥ 2.8 Nm
UL486E	# 6-1 AWG	4 Nm

## Lockout Attachment

IS/SPE-1TE

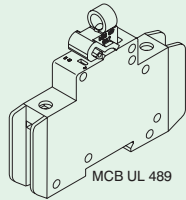
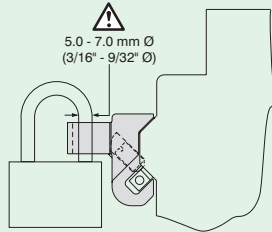
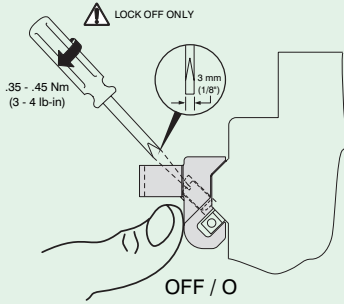

Device Market Current Rating in (A) @ 40° C	In (A) at higher Ambient Temperature							
	15° C	20° C	25° C	30° C	40° C	50° C	55° C	60° C
0.5	0.6	0.5	0.5	0.5	0.5	0.5	0.5	0.5
1.0	1.1	1.1	1.1	1.0	1.0	1.0	0.9	0.9
1.5	1.7	1.6	1.6	1.6	1.5	1.4	1.4	1.4
2.0	2.2	2.2	2.1	2.1	2.0	1.9	1.9	1.8
3.0	3.3	3.2	3.2	3.1	3.0	2.9	2.9	2.8
4.0	4.4	4.3	4.2	4.2	4.0	3.8	3.8	3.7
5.0	5.5	5.4	5.3	5.2	5.0	4.8	4.7	4.6
6.0	6.6	6.5	6.4	6.2	6.0	5.8	5.6	5.5
7.0	7.7	7.6	7.4	7.3	7.0	6.7	6.6	6.4
8.0	8.8	8.6	8.5	8.3	8.0	7.7	7.5	7.4
10.0	11.0	10.8	10.6	10.4	10.0	9.6	9.4	9.2
13.0	14.3	14.0	13.8	13.5	13.0	12.5	12.5	12.0
15.0	16.5	16.2	15.9	15.6	15.0	14.4	14.1	13.8
16.0	17.6	17.3	17.0	16.6	16.0	15.4	15.0	14.7
20.0	22.0	21.6	21.2	20.8	20.0	19.2	18.8	18.4
25.0	27.5	27.0	26.5	26.0	25.0	24.0	23.3	23.0
30.0	33.0	32.4	31.8	31.2	30.0	28.8	28.2	27.6
32.0	35.2	34.6	33.9	33.3	32.0	30.7	30.1	29.4
40.0	44.0	43.2	42.4	41.6	40.0	38.4	37.6	36.8

**Moeller Gebäudeautomation GmbH  
Eugenia 1  
A-3943 Schrems**

**E-mail: [sales.lowvoltage.systems@moeller.net](mailto:sales.lowvoltage.systems@moeller.net)  
Internet: [www.moeller.at](http://www.moeller.at)**

© 2008 by Moeller Gebäudeautomation  
Subject to alterations  
Printed in Austria (09/08)  
Layout: SRA  
Print: Druckerei Rabl, Schrems  
W0207+0075-7577GB  
Article No. 104825



*Powering Business Worldwide*

Eaton's electrical business is a global leader in electrical control, power distribution, uninterruptible power supply and industrial automation products and services.

Eaton's global electrical brands, including Cutler-Hammer®, MGE Office Protection Systems™, Powerware®, Holec®, MEM®, Santak and Moeller, provide customer-driven PowerChain Management® solutions to serve the power system needs of the industrial, institutional, government, utility, commercial, residential, IT, mission critical and OEM markets worldwide.

**[www.eaton.com](http://www.eaton.com)**

**MOELLER** 

**An Eaton Brand**